

This is a blank page.

This is a blank page.

TABLE OF CONTENTS

Introduction	1
Connecting CallExtend to Your Phone System	2
Your CallExtend Unit.....	2
Testing the Phone System Extension Ports	2
Cabling CallExtend to Your Phone System	3
Inserting the Battery Backup.....	4
Understanding CallExtend Programming	5
CallExtend’s Programmable Memory	5
Programming Format for Data	7
Programming Commands for Data.....	8
Programming System Settings: PAGE 0, ROW 0	9
Hook-Flash Duration.....	9
Pause between Greeting & Transfer.....	10
Transfer Supervision Modes	10
Optional System Programming	11
Programming Receptionist Extensions	13
Programming the Main Receptionist(s)	14
Programming the BDA Receptionist(s).....	15
Programming PAGE Receptionist(s)	16
Hints on Receptionist Extensions.....	17
Programming Direct Extension Transfers	19
Having CallExtend Dial Digits before or after Direct-Dialed Extensions	20

Programming Single Digit Transfers from a Menu	21
Single Level Menu Transfers	21
Second Level Menu Transfers.....	23
Recording Voice Messages	25
Programming Format for Voice Messages.....	26
Programming Commands for Voice Messages	27
Recording the Main Greeting	28
Recording a PAGE Message	29
Recording a Transfer Message.....	30
Recording a Busy-Don’t-Answer Message	31
Erasing Voice Messages.....	31
Remaining Voice Message Storage.....	32
Appendix A: Data Display	33
Appendix B: Optional Programming	35
Call Supervision in Phone Systems that Don't Provide Ringing to CallExtend	36
Disconnecting Busy/Unanswered Call Transfers	36
Alternate Handling of Calls Where the Caller Doesn’t Dial Anything	36
When PBX Conference Calling is Enabled.....	37
Having CallExtend Answer Calls after Several Rings	37
Selecting a Digit to Repeat Messages When Dialed	37
Receptionist Numbers Longer than 8 Digits	37
Transferring Calls to Off-Site Receptionists	37
Using Separate Receptionists for Port 1 & Port 2	38
Having CallExtend PAUSE while Dialing.....	38
Having CallExtend Hook-Flash between Dialed Digits.....	38
Having CallExtend Detect a Different Calling Party Abandon.....	39
Appendix C: Troubleshooting	41

Introduction

CallExtend is a two-port automated attendant that answers and routes your incoming phone calls without your intervention.

CallExtend is available in three models:

↓ **The Basic Model**, with 32 seconds of voice recording capability per port.

↓ **The Intermediate Model**, with 1 minute of voice storage per port.

↓ **The Deluxe Model**, with 2 minutes of voice storage per port.

CallExtend can be connected to one or two analog extension ports on a PBX or hybrid key phone system that has hook-flash call transfer capability. When CallExtend answers a call, it plays a user-recorded message, inviting the caller to dial an extension or a single digit to reach a particular department. CallExtend can process up to two incoming calls simultaneously.

While playing its message and for a period of time afterwards, CallExtend listens for any digits dialed by the caller. Based on what is dialed, the call is then routed to a department, to a secondary menu, or directly to an extension. If no digits are dialed, or if "0" is dialed, the call is routed to the receptionist(s).

If desired, CallExtend can supervise call transfers, directing unanswered calls to an appropriate receptionist, or disconnecting these calls if desired. Alternately, it can transfer the call to the desired extension and then immediately exit from the call. CallExtend is then free to handle the next incoming call.

Connecting CallExtend to Your Phone System

Your CallExtend Unit:

Your CallExtend package contains a CallExtend unit, a power transformer, this User's Manual, and a Programming Guide.

The CallExtend unit has ports labeled PORT 1 and PORT 2 that must first be connected to 1 or 2 analog extension ports on your phone system. A standard touch-tone phone connects to the ADMIN port for programming CallExtend. The power transformer connects to the port labeled POWER and then to an A/C wall outlet.

This manual details the procedures you should follow to connect and program CallExtend. The *Programming Guide* provides a place to record your programming.

Testing the Phone System Extension Ports:

IMPORTANT: Before connecting CallExtend to the extension ports of your phone system, make sure that the ports are **analog** and **that they will perform incoming call transfers**.

To test the analog port(s), first program your phone system to route incoming calls to the port(s) CallExtend will be connected to. Then connect a standard touch-tone phone to one of these extensions. From another phone, obtain an outside phone line and make a test call into the phone system. This call should ring the phone you have connected. Answer the call and try to transfer it to an extension. If this test transfer works, CallExtend will operate properly on this port. If you plan to use a second extension port with CallExtend, test that port as well.

CallExtend will not work on extension ports that will not perform call transfers.

Cabling CallExtend to Your Phone System:

After testing the phone system's analog extension ports, you are ready to connect CallExtend to these extensions. Use standard modular cords with RJ11C connectors, as shown in Figure 1.

Your phone system should be programmed to route incoming calls to the extension port(s) CallExtend is connected to.

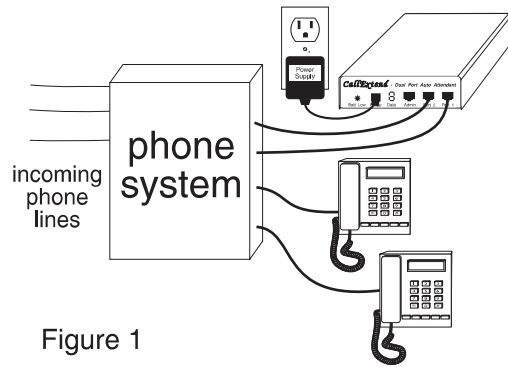
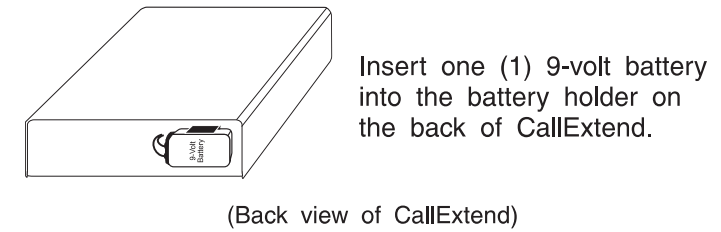

Figure 1

Note: Typically, if both ports of CallExtend are to be used, incoming calls should be routed first to the phone system extension that is connected to CallExtend's Port 1. Calls should then hunt to the phone system extension connected to CallExtend's Port 2. Do **not** have each incoming call ring simultaneously to both of the phone system extensions that CallExtend is connected to.

Inserting the Battery Backup:

A standard 9-volt battery can be inserted on the back of the CallExtend unit to prevent loss of the voice messages during power failures (see Figure 2). CallExtend stores all of its programmed settings, except the voice messages, in non-volatile RAM, so these settings are **not** erased when there is a power failure.



(Back view of CallExtend)

Figure 2

If the battery runs out (or if no battery is inserted in CallExtend), CallExtend will only lose the voice messages when there is a power failure. Once power is returned, it will answer calls, but it will not have a greeting to play to the caller. When CallExtend is powered on, it will light up the "Battery Low Light" on the front panel to indicate low battery voltage or no battery attached.

Understanding CallExtend Programming

After CallExtend has been connected to your phone system, it must be programmed. CallExtend is programmed by dialing digits on a standard touch-tone phone connected to the ADMIN port of the unit.

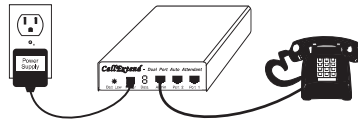

Figure 3

CallExtend's Programmable Memory:

PAGES: CallExtend's programmable memory consists of banks of data storage called PAGES. PAGES 0-9 tell CallExtend how to handle call transfers. Program the PAGES that correspond to each first digit a caller can dial (e.g., program PAGES 1 & 2 if callers can dial 1 for sales or dial extensions 210, 220, etc.). PAGE * is used to program additional system settings.

ROWS: Each PAGE of CallExtend memory has room for ten ROWS (0-9) of instruction sets detailing how to transfer calls.

DATA: And each ROW on the PAGE can store up to eight fields (single touch-tone digits) of DATA.

Following is a graphical representation of this memory storage system:

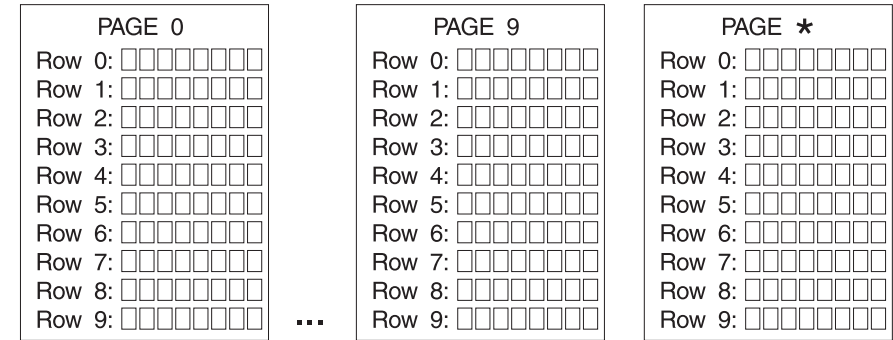

When you begin programming CallExtend, you will first program **PAGES 0 and *** with your **system settings** and your **receptionist extensions**.

Then, you will program **each PAGE of CallExtend memory that corresponds to the first digit to be dialed by a caller**. PAGES can be programmed for direct extension dialing or single digit dialing from a menu. Last of all, you will program your **voice messages**.

For example: If you want to have callers dial directly to extensions that start with a 1, you will program PAGE 1 of CallExtend with the instructions for direct extension dialing. If you want to have callers dial a 2 to reach extension 100, you will program PAGE 2 with the instructions for menu dialing. If you want to have callers dial a 3 to reach a second-level menu, you will program PAGE 3 with this second-level menu.

You need only program PAGE 0 and the PAGES of CallExtend that correspond to the first digits callers will be dialing.

The **CallExtend Programming Guide** included with this manual has a separate sheet for each PAGE of CallExtend's memory, for you to record your programming entries.

Programming Format for Data:

To program CallExtend, you will dial digits on a touch-tone phone connected to the ADMIN port. All programming is done in the format **PAGE - ROW - COMMAND - DATA** that corresponds to the configuration of CallExtend's memory. As you program CallExtend, the display will prompt you as follows:

P

Enter the PAGE number to be programmed

r

Enter the ROW number to be programmed

C

Hold down the COMMAND key (**5** = Enter Data, **7** = Review Data) for a full second

d

Enter the DATA (if using the Enter Data command)

When you first lift the ADMIN phone handset, CallExtend will prompt you with a **P**, asking for the PAGE number you want to program. Then, it will show an **r** to request the ROW number. Next, it will show a **C** to request the COMMAND; press *and hold down* the command key for at least one full second. If you use the Enter Data command, the display will show **d** to prompt you to enter your DATA; if you use the Review Data command, the DATA currently stored in this ROW of the PAGE will be displayed. Note: When using the Enter Data command to enter fewer than 8 characters of DATA, dial a single **#** sign at the end of the data to indicate you're done. **For more information on CallExtend's display, see Appendix A.**

For example: **To program PAGE 1**, you would lift the ADMIN phone handset, look for **P** on the CallExtend display, and:

Dial: **1** (to program PAGE 1); CallExtend will next show **r**.

Dial: **0** (to program ROW 0); CallExtend will next show **C**.

Dial: **5** (the COMMAND to enter DATA) -- **hold the 5 down until you see d**.

Dial: **x** (where x corresponds to the DATA you want to enter).

Dial: **#** if you enter fewer than 8 digits of DATA.

The **CallExtend Programming Guide** that came with this manual indicates what to dial and allows you to write down your DATA before you enter it into CallExtend.

NOTE: You cannot program CallExtend while it is in the process of handling a call. Wait until the call has been transferred and then pick up the Admin Phone to enter programming mode. While CallExtend is in programming mode, it will not answer incoming calls. To resume normal operation, hang up the Admin Phone.

Programming Commands for Data:

When programming CallExtend, you will need to enter a **COMMAND** after the PAGE and ROW numbers to tell CallExtend whether you are Entering Data or Reviewing Data you already entered.

There are two DATA commands in CallExtend:

- 5** ENTERS Data into a ROW on a PAGE
- 7** REVIEWS Data in a ROW on a PAGE

Each COMMAND digit dialed on the ADMIN phone must be held down for at least one full second to be considered a legal command by CallExtend. For example: When entering DATA into a ROW, you must hold down the **5** key (Enter Data Command) until a **d** appears on the display. Command keys are highlighted in gray in this manual to help them stand out from other digits you dial.

Programming System Settings: PAGE 0, ROW 0

PAGE 0 of CallExtend's memory is used to set up **system information** and to enter your **receptionist extensions**. **ROW 0 of PAGE 0** contains **three fields that must be programmed** and five optional fields (described in Appendix B). To program this ROW, lift the handset on the ADMIN phone and dial as follows:

	Field 1	Field 2	Field 3	
Dial: 0 0	5	 	 	#
	Single digit for phone system's Hook-flash duration (see table)	Number of seconds 0-9 to wait after greeting for caller to dial	Single digit for Transfer Supervision Mode desired	
Dial: 0 0	7	to review the DATA you entered & make sure it's correct.		

highlighted digit = Hold this key down for at least one full second

FIELD 1: Hook-Flash Duration:

Field 1 on PAGE 0, ROW 0 should be programmed to match as closely as possible the hook-flash duration used by your phone system for call transfers. Find your phone system's hook-flash duration in the following table (if your phone system is set to accept a range of hook flashes, select a value that is in the middle of this range) and **enter the single digit 0-9** shown for that duration into Field 1:

no hook-flash.....	0	600 ms.....	5
250 ms	1	750 ms.....	6
300 ms	2	900 ms.....	7
400 ms	3	1 sec	8
500 ms	4	1.5 sec	9

FIELD 2: Pause Duration After Greeting:

After CallExtend plays its initial voice greeting (the main greeting) to a caller, it will pause the number of seconds programmed into this field to give the caller time to dial an extension or a single digit. If the caller doesn't dial within this time, the call will be transferred to the receptionist. **Enter the number of seconds (0-9) to wait.**

FIELD 3: Transfer Supervision Mode:

This field tells CallExtend how to supervise call transfers. CallExtend can be programmed for one of three supervision modes:

⇒ **Full Supervision:** In this mode, CallExtend will *fully supervise call transfers, looking for both busy and no answer conditions*. To select full supervision mode, **enter a digit 2-9 in Field 3**, representing the number of rings CallExtend should hear before declaring the call unanswered and transferring it to the receptionist. Enter **★** for 12 rings or a **#** character (dial **##** to enter a **#** character into this field) for 16 rings. CallExtend will send calls transferred to busy extensions directly to the receptionist without delay.

Hints on Full Supervision Mode:

- ◆ **If desired, CallExtend can disconnect callers instead of transferring them to the receptionist if the extension is busy or does not answer.** In this Mode, CallExtend will play the "Busy - Don't Answer Message" (e.g., "That extension is not answering; please try again later.") and then disconnect the caller. To use this Mode, see Appendix B, Case B.
- ◆ **CallExtend will connect a call through to an extension upon hearing a voice answer.** This connection may take a moment, so the first word said by the answering party may not be heard by the caller.
- ◆ While CallExtend is supervising the call transfer, the phone system will have the call in an "On Hold" status, so **the calling party may NOT hear ringing or busy tone**. The caller will hear what the phone system puts out to a caller on hold.

- ◆ **In some phone systems, ringing will not be sent to the extension originating a call transfer.** In this case, CallExtend can be programmed to wait for a period of TIME before transferring to a receptionist, rather than to listen for ringback. See Appendix B, Case A for this programming.

⇒ **Busy-Only Supervision:** Enter a **1 (one)** in **Field 3** to select this mode. In this mode, if CallExtend *detects a busy tone from the extension it is transferring the call to, it will transfer the call to the receptionist.* If ringing is heard from the extension, CallExtend will connect the call through to the extension and exit immediately. If the extension rings and is not answered, CallExtend will **NOT** send the call to the receptionist.

⇒ **Unsupervised:** Enter **0 (zero)** in **Field 3** to have CallExtend *transfer calls without supervision.* In this mode, CallExtend will connect the call through to the desired extension and then immediately exit the call. CallExtend will **NOT** send the call to the receptionist(s) if the dialed extension is busy or does not answer.

FIELDS 4 - 7: Optional System Programming:

PAGE 0, ROW 0 has five additional fields that can be programmed for various optional settings. In addition, PAGE *, ROW 0 contains optional system settings. All of these are covered in depth in **Appendix B, Optional Programming.** See this appendix for additional system settings, such as how to:

- ◆ Have CallExtend answer calls on greater than 1 ring
- ◆ Have CallExtend pause during dialing
- ◆ Transfer calls to an off-site receptionist
- ◆ Designate a digit callers can dial to replay the voice greeting
- ◆ Control whether the Transfer Message or the Busy-Don't-Answer Message plays to callers who don't dial anything from the main greeting
- ◆ Direct calls answered by CallExtend's Ports 1 & 2 to different receptionists

- ◆ Use an extra hook-flash during call transfers (required by some phone systems' conference calling features)
- ◆ Have CallExtend detect a different calling party abandon signal

Programming Receptionist Extensions

There are three types of receptionist extensions that can be programmed into CallExtend:

MAIN RECEPTIONISTS:

Up to four receptionist extensions can be programmed into PAGE 0, ROWS 1-4 to serve as the main receptionists. Calls will be directed to the main receptionist(s) if the caller dials 0 during or after the main greeting, does not dial anything, or dials an invalid digit.

BUSY-DON'T-ANSWER (BDA) RECEPTIONISTS:

Up to four receptionist extensions can be programmed into PAGE *, ROWS 1-4 to serve as BDA receptionists. Calls will be directed to the BDA receptionist(s) if the original extension the call is transferred to is busy or doesn't answer and CallExtend is in supervised mode.

PAGE RECEPTIONISTS:

A single receptionist extension can be programmed into each PAGE 1-9, ROWS 8-9 to serve as a receptionist for calls handled by that PAGE. This field allows a different receptionist to be used for each category of calls (e.g., calls where the caller dials "1 for sales" from the main greeting can go to one receptionist and calls where the caller dials "2 for technical support" can go to another).

These three types of receptionist extensions are described in detail next.

Programming the Main Receptionist(s):

At least one Main Receptionist extension must be programmed, into PAGE 0, ROW 1 of CallExtend. Up to four Main Receptionist extensions can be programmed, into PAGE 0, ROWS 1-4.

Calls will be transferred to the Main Receptionist extension if:

- 1.) The caller **does not dial anything** within the time limit programmed on PAGE 0, ROW 0, Field 2.
- 2.) The caller dials a **digit not recognized** by CallExtend.
- 3.) The caller **dials a 0** during or after the voice greeting.

To program the first receptionist extension into PAGE 0, ROW 1, lift the handset on the ADMIN phone and dial as follows:

Dial: 0 1 **5** plus an extension up to 8 digits long; if less than 8, dial # when done.

Dial: 0 1 **7** to review the extension you entered & make sure it's correct.

highlighted digit = Hold this key down for at least one full second

Each extension can be up to 8 digits long (to use an extension longer than 8 digits, see the following "Hints on Receptionist Extensions" section). When programming an extension shorter than 8 digits, press a single # sign to indicate that you are done entering the extension number. If you want to include a # as part of an extension, dial two # signs right in a row in the appropriate place in the extension.

To program additional receptionist extensions into PAGE 0, ROWS 2-4, dial as shown above. However, replace the ROW number (the second digit to be dialed) with the ROW number being programmed.

Programming the BDA Receptionist(s):

Up to four Busy-Don't Answer (BDA) Receptionist extensions can be programmed, into PAGE *, ROWS 1-4. **If no BDA Receptionists are programmed, the Main Receptionist will be used for calls that meet the BDA criteria.**

Calls will be transferred to the BDA Receptionist extension if:

- 1) CallExtend is programmed for the **Full Supervision** or **Busy-Only Supervision** mode and the conditions for receptionist transfers are met,
AND
- 2) No PAGE Receptionist has been programmed for the PAGE the caller accessed by dialing from CallExtend's Main Greeting.

To program the first receptionist extension into PAGE *, ROW 1, lift the handset on the ADMIN phone and dial as follows:

Dial: * 1 5 plus an extension up to 8 digits long; if less than 8, dial # when done.

Dial: * 1 7 to review the extension you entered & make sure it's correct.

Each extension can be up to 8 digits long (to use an extension longer than 8 digits, see the following "Hints on Receptionist Extensions" section). When programming an extension shorter than 8 digits, press a single # sign to indicate that you are done entering the extension number. If you want to include a # as part of an extension, dial two # signs right in a row in the appropriate place in the extension.

To program additional receptionist extensions into PAGE *, ROWS 2-4, dial as shown above. However, replace the ROW number (the second digit to be dialed) with the ROW number being programmed.

Programming PAGE Receptionists:

A single PAGE Receptionist extension up to 16 digits long can be programmed for each PAGE 1-9 of CallExtend's memory. The extension is programmed into ROWS 8-9 of that PAGE. If no PAGE Receptionist is programmed, calls to extensions that are busy or don't answer will be directed to the BDA Receptionist, or if no BDA Receptionist has been programmed, to the Main Receptionist.

Calls will be transferred to a PAGE Receptionist extension if:

- 1) CallExtend is programmed for the **Full Supervision** or **Busy-Only Supervision** mode and the conditions for receptionist transfers are met,
AND
- 2) The caller dialed the appropriate digit for this PAGE from CallExtend's Main Greeting (e.g., if the caller dialed "1" and a PAGE Receptionist has been programmed for PAGE 1).

Example: To program a PAGE Receptionist for PAGE 1, lift the handset on the ADMIN phone and dial as follows:

Dial: 1 8 5 plus the first 8 digits of the extension; if the extension is less than 8 digits long, dial # when you're done dialing.

Dial: 1 8 7 to review the digits you entered & make sure they're correct.

Dial: 1 9 5 plus the remainder of the extension (if any); if less than 8 digits, dial # when done.

Dial: 1 9 7 to review the digits you entered & make sure they're correct.

This PAGE Receptionist would then be used for calls where the caller dialed "1" from the Main Greeting, but the extension originally tried was busy or didn't answer. To program additional PAGE Receptionist extensions, dial as shown above; however, replace the PAGE number (the first digit to be dialed) with the PAGE number being programmed.

Hints on Receptionist Extensions:

- ◆ **CallExtend does not supervise calls sent to the receptionist.** You should either program receptionist extensions that will always be answered or specify the starting extension of a phone system hunt group as the receptionist.
- ◆ **CallExtend does not hunt through multiple receptionist extensions.** If more than one receptionist extension is programmed into PAGE 0 or PAGE *, ROWS 1-4, CallExtend will transfer the first call to the first receptionist extension (in ROW 1) and the next call to the second receptionist extension (ROW 2), *even if the first receptionist is available*. If you need to have calls be sent to multiple receptionists, it is often better to set these receptionists up as a phone system hunt group.
- ◆ **Enter each extension number exactly as CallExtend must dial it for the phone system to transfer the call.** If the phone system needs to see *70 at the beginning of a call transfer sequence, enter *70 at the beginning of each receptionist extension (e.g., enter *70212 for extension 212). To have CallExtend dial a # as part of a number, program a # character in the appropriate location by dialing ## (two # signs right in a row) from the Admin phone.
- ◆ **To use an extension or phone number up to 16 digits long as the Main Receptionist or the BDA Receptionist:** enter the first eight digits of the number into ROW 1 of the PAGE (PAGE 0 or PAGE *); then enter the remainder of the number into ROW 2. ROWS 3 and 4 of both PAGES 0 and * will be ignored after this, so only one Main Receptionist and one BDA Receptionist can be used in this case. When using a Main or BDA Receptionist extension longer than 8 digits, you must also enter a # character (dial ## to enter a # character) into Field 7 of PAGE 0, ROW 0, as described in Appendix B, Case G. Also see Appendix B for additional receptionist options.
- ◆ **If CallExtend is set to supervise call transfers** (in Full Supervision or Busy-Only Supervision Mode), CallExtend will transfer each busy/unanswered call to a single receptionist extension. To determine which receptionist to use, it

will look through the receptionists in the following order until it finds a programmed receptionist:

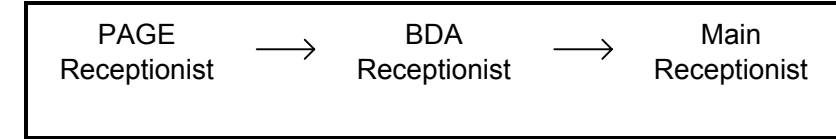

Once CallExtend finds a programmed receptionist, it will immediately transfer the call to this receptionist. This transfer is made without supervision.

- ◆ **To remove an extension from the Main or BDA Receptionist list,** use a single # sign to erase the contents of the applicable ROW. For example, to erase the contents of PAGE 0, ROW 1, dial **0 1 5** (hold the **5** down for a full second) **#**. CallExtend will still use the extensions before and after the empty ROW on the list.

Programming Direct Extension Transfers: PAGES 1-9

PAGES 1-9 of CallExtend's memory tell CallExtend how to respond to what callers dial. Each PAGE of CallExtend memory corresponds to the first digit dialed by the caller. For example, if a caller dials "214," CallExtend will examine PAGE 2 of its memory for instructions on how to handle the call.

If you want to have callers dial extensions directly, program the length of your extensions into ROW 0 of the PAGE(S) that correspond to the first digit(s) of your extensions. This is all the data entry you will need to do on these PAGES.

For example, if your extensions are all in the 100's (100, 101, 102, etc.), you would program PAGE 1, ROW 0 for a 3-digit extension format. CallExtend will accept extensions up to 8 digits long for direct extension dialing.

To program direct extension dialing, dial the following on the ADMIN phone for each PAGE that corresponds to the first digit of an extension:

Dial: PAGE number 1-9 then 0 5 then the extension length, then: #
Dial: PAGE number 1-9 then 0 7 to review the ext length & make sure it's correct.

Example: If your phone system uses 3-digit extensions that begin with either "1" or "2" (100, 110, 200, etc.), program PAGES 1 and 2 as shown:

PAGE 1 -	Dial:	1	0	5	3	#
	Dial:	1	0	7	Verify the display shows 3	
PAGE 2 -	Dial:	2	0	5	3	#
	Dial:	2	0	7	Verify the display shows 3	

Special digit dialing: If your phone system requires that special digits be dialed in front of an extension number when transferring calls, you should enter the special digits AFTER the extension length when programming ROW 0 of the PAGE(S). For the extension length, you would enter the total of the special digits and the number of digits in the extension. CallExtend will insert the special digits in front of the extension a caller dials.

Example: The ABC Company uses extensions that begin with "5" and are three digits long (e.g., 503, 515, 532, etc.). In order to transfer a call, their phone system requires that *70 be dialed before the extension number. CallExtend would be programmed as follows:

PAGE 5 -	Dial:	5	0	5	6	*	7	0	#
	Dial:	5	0	7	Verify the display shows 5 7 0				

If your phone system requires that special digits be dialed after the extension number when transferring calls, you can enter these special digits on ROW 1 of the PAGE(S). Do not include these digits in the total extension length programmed into ROW 0.

Example: The CBA Company uses extensions that begin with "2" and are three digits long (e.g., 201, 210, 222, etc.). In order to transfer a call, their phone system requires that 1 be dialed after the extension number. CallExtend would be programmed as follows:

Page 2, Row 0 -	Dial:	2	0	5	3	#
	Dial:	2	0	7	Verify the display shows 3	
Page 2, Row 1 -	Dial:	2	1	5	1	#
	Dial:	2	1	7	Verify the display shows 1	

Programming Single Digit Transfers from a Menu: PAGES 1-9

PAGES that are not used for direct extension transfers can be used for single-digit dialing from a menu, if desired. CallExtend is capable of performing up to two levels of menu transfers.

Single Level Menu Transfers:

To program a PAGE for single level menu transfers, you will first program a ★ into ROW 0 of the PAGE and then enter the extensions that you want calls transferred to into ROWS 1-6 of the PAGE.

For example, to have callers "dial 4 for Support," you would enter a ★ in PAGE 4, ROW 0 and up to six extensions for the Support Department into ROWS 1-6 of PAGE 4.

Each extension in a ROW can be up to 8 digits long (to use an extension longer than 8 digits, see the following Hints). When programming an extension shorter than 8 digits, press a single # sign to indicate that you are done entering the extension number. If you want to include a # as part of an extension, dial two # signs right in a row in the appropriate place in the extension.

Example: The ABC Company wants callers to be able to dial 3 for Sales and wants those calls to be sent to extension 117. To accomplish this, you would program PAGE 3 by dialing the following on the ADMIN phone:

Page 3, Row 0 - Dial: 3 0 5 ★ #
 Dial: 3 0 7 Verify the display shows ##

This enters a ★ (star) into PAGE 3, ROW 0. Next, extension 117 is entered into PAGE 3, ROW 1:

Page 3, Row 1 - Dial: 3 1 5 1 1 7 #
 Dial: 3 1 7 Verify the display shows 1 1 7

Hints on Programming Menu Dialing:

- ◆ **Enter each extension number exactly as the phone system needs to see it to transfer the call.** If the phone system needs to see ★70 at the beginning of an extension to transfer a call, enter ★70 at the beginning of each extension you enter in CallExtend (e.g., enter ★70117 for ext 117). You can enter an off-premise phone number, hunt group, or voice mailbox number by programming the exact digits to be dialed, including an initial "9" or "1." To have CallExtend dial a # as part of a number, program a # character in the appropriate location by dialing ## (two # signs right in a row) from the Admin phone. To have CallExtend pause during dialing, see Case I in Appendix B.
- ◆ **A phone number up to 16 digits long can be entered into CallExtend as the *only* number in the menu list.** To program this, enter a # character (dial ## to enter a # character) instead of a ★ in ROW 0 of the PAGE. Then, enter the first eight digits of the number into ROW 1 of the PAGE and enter the remainder of the number into ROW 2. ROWS 3-6 of the PAGE will be ignored after this.
- ◆ **To remove an extension from a department list,** use a single # sign to erase that ROW. Example: to erase the contents of PAGE 2, ROW 1, dial 2 1 5 (hold the 5 down for a full second) #. CallExtend will still use the extensions before & after the empty ROW.
- ◆ **CallExtend does not hunt through multiple extensions on a department list.** If more than one extension is programmed, CallExtend will transfer the first call to the extension in ROW 1 and the next call to the extension in ROW 2, *even if the first extension is available*. If you want calls to be sent to a hunt group, program the hunt group extensions into the phone system, and only the starting extension of the hunt group into CallExtend.

Second-Level Menu Transfers:

Up to nine Second Level Menus can be programmed in CallExtend, to allow callers to dial a single digit from the Main Greeting and get an:

- 1.) **Additional menu** of single digit dialing choices

OR

- 2.) **Information message**, such as directions to the company or office hours

A second level menu is programmed on the PAGE of CallExtend memory that corresponds to the single digit the caller dials from the Main Greeting (e.g., PAGE 3 if “3” is dialed from the Main Greeting). Instead of programming a ***** in ROW 0 of the PAGE, enter a value from the following chart to fit your application:

9	Allows you to enter up to six extensions on this PAGE, with each extension up to 8 digits long . Callers will dial a single digit 1-6 from the second menu to reach each desired extension.
0	Allows you to enter up to three extensions on this PAGE, with each extension up to 16 digits long . Callers will dial 1, 3, or 5 from the second menu to reach the desired extension.
#*	Allows you to have an information voice message rather than a second menu of dialing options. Callers will hear this second voice message and then be disconnected .

With a 9 or 0 programmed in ROW 0 of this PAGE, callers will first dial the appropriate single digit from the Main Greeting and then hear a second voice message prompting them to dial another single digit, 1-6. The extensions to be reached by this second level of dialing are entered next:

If 9 is programmed in ROW 0: you will program ROWS 1-6 of this PAGE with the extensions callers will reach by dialing the second single digit 1-6. **The digit dialed is the ROW number** (e.g., the extension programmed in ROW 2 of the PAGE is reached by callers dialing “2”). Each extension can be up to 8 digits long.

If 0 is programmed in ROW 0: enter the first 8 digits of each extension in the ROW that corresponds to the digit callers will dial (1, 3, or 5), and enter the remainder of the extension in the next ROW (e.g., if callers will dial “3,” enter the first 8 digits of the extension in ROW 3 and the rest of the extension in ROW 4).

Recording the Second Level Voice Message is explained in the “Recording Voice Messages” section that follows (under the “Recording a PAGE Message” instructions).

The following example shows how to program CallExtend for a second level menu:

Example: In their main greeting, the ABC Company asks callers to dial 4 for Technical Support; callers dialing “4” will hear a second menu allowing them to choose which of two products they want support on, so they can be directed to the appropriate technician. Callers will be prompted to dial 1 for Product A and 2 for Product B. Extension 101 will handle calls for Product A, and extension 105 will handle calls for Product B. To program this, you would program PAGE 4 by dialing the following on the ADMIN phone:

Page 4, Row 0 - Dial: 4 0 5 9 #
 Dial: 4 0 7 Verify the display shows 9

This enters a 9 into PAGE 4, ROW 0, as described in the previous chart. Next, the extensions are entered into PAGE 4, ROWS 1 and 2:

Page 4, Row 1 - Dial: 4 1 5 1 0 1 #
 Dial: 4 1 7 Verify the display shows 1 0 1
 Page 4, Row 2 - Dial: 4 2 5 1 0 5 #
 Dial: 4 2 7 Verify the display shows 1 0 5

Recording Voice Messages

CallExtend is available in a **Basic Model**, allowing up to 32 seconds of digital voice storage on each port, an **Intermediate Model**, allowing up to 1 minute of digital voice storage on each port, and a **Deluxe Model**, allowing up to 2 minutes of digital voice storage on each port. Different main greetings can be recorded for each port in all models, if desired. All voice storage is for outgoing messages only and is not designed for voice mail.

All three models of CallExtend allow you to record **Four Types of Voice Messages** to be heard by the calling party:

MAIN GREETING:

This is the initial message played to all callers when CallExtend answers the incoming call.

PAGE MESSAGE:

This is an optional message that will play to callers in response to the dialing of a specific digit. Each PAGE 1-9 of CallExtend memory can have a single voice message associated with it. This is useful for informative messages, such as *directions to the company*, or for a message prompting callers to dial from a *second level menu*.

TRANSFER MESSAGE:

This is an optional message that will play to callers after they have finished dialing but before the call is connected to an extension. This message will play after the MAIN GREETING and after any PAGE MESSAGE that might be recorded. This can be used for messages such as, *“Please hold while I try that extension.”*

BUSY - DON'T ANSWER (BDA) MESSAGE:

This message plays to callers after an unsuccessful call transfer attempt, but before the call is transferred to the receptionist. This message will

generally be something like, *“That extension is not answering; your call is being transferred to the receptionist.”*

The following chart shows the organization of CallExtend’s voice storage. CallExtend’s voice storage is comparable to a cassette tape, and all your messages **must** be recorded in this order:

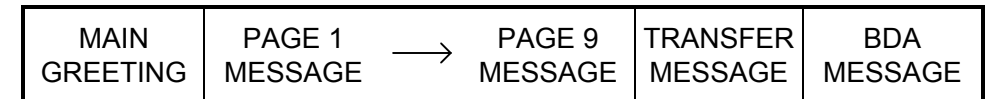

IMPORTANT: If you need to re-record a message, you must first ERASE the old message and then record the new one in its place. Note that only the last message you recorded can be erased and re-recorded. If you need to re-record an earlier message, erase all messages and re-record them all in the order shown above.

Programming Format for Voice Messages:

CallExtend’s voice messages are recorded the same way other programming is done: by using a standard touch-tone phone on the ADMIN port. The format for voice programming is: **PAGE -- ROW -- COMMAND -- SPEECH**

Now, instead of entering DATA after a COMMAND, you will speak into the ADMIN phone handset. The COMMAND digit will still need to be held for at least one second, until the Data display changes to **5** – then release the command digit and begin recording or listening.

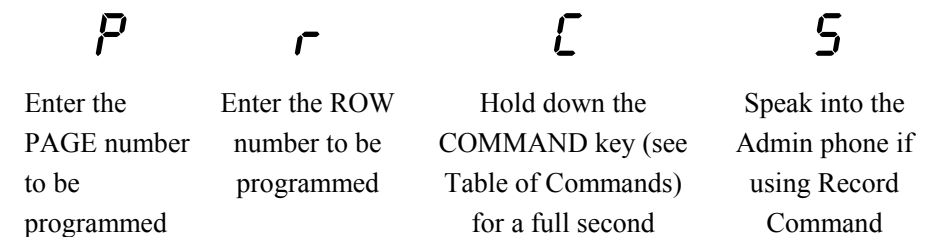

Programming Commands for Voice Messages:

Just as the digits **5** and **7** are used to **ENTER** data into CallExtend and to **REVIEW** it, other digits are used to **RECORD**, **REVIEW**, and **ERASE** voice messages.

The following table shows the **Voice Recording Commands** and their function. The most commonly used commands are shown in bold type.

1	RECORDS Message for Both Ports at PAGE, ROW
2	RECORDS Main Greeting for Port 1 only; use from PAGE 0, ROW 7
3	RECORDS Main Greeting for Port 2 only; use from PAGE 0, ROW 7
4	ERASES Message from Both Ports at PAGE, ROW
6	ERASES Main Greeting from Port 1 only; use from PAGE 0, ROW 7
8	ERASES Main Greeting from Port 2 only; use from PAGE 0, ROW 7
9	ERASES ALL voice messages; use from PAGE 0, ROW 7
0	REVIEWS Message on Port 1, at PAGE, ROW
*	REVIEWS Message on Port 2, at PAGE, ROW

Each voice message is programmed into a particular PAGE and ROW location. The **Main Greeting**, **Transfer Message**, and the **Busy-Don't-Answer (BDA) Message** are all programmed into **PAGE 0**, in the ROWS shown in the following chart. The **PAGE Messages** are programmed into ROW 7 of the **PAGES** that correspond to the first digit the caller will dial from the Main Greeting.

Message	PAGE	ROW
BDA Message	<i>0</i>	<i>5</i>
Transfer Message	<i>0</i>	<i>6</i>
Main Greeting	<i>0</i>	<i>7</i>
PAGE Message	<i>1-9</i>	<i>7</i>

Recording the MAIN GREETING:

The Main Greeting will be heard by all callers when CallExtend answers the incoming call. This greeting generally identifies your company and invites callers to dial an extension or dial a single digit from a menu.

Main Greeting Example: “You have reached the ABC Company. If you know your party’s extension, you can dial it at any time. For Sales, dial 3, for Technical Support, dial 4, and for our address, dial 6. If you do not have a touch tone phone, or if you would like to speak to an operator, please stay on the line and someone will assist you shortly. To repeat this message, dial *****.”

The Main Greeting is programmed on PAGE 0, ROW 7. You can either record the same greeting for both Ports 1 & 2 of CallExtend or record a different greeting for each port. **To record the same greeting on both CallExtend ports**, you would dial the following on the ADMIN phone:

Dial: **0 7 1** *Speak into the Admin Phone to record the greeting; hang up when done.*

Dial: **0 7 0** *Listen to the greeting.*

highlighted digit = Hold this key down for at least one full second

Different Main Greetings can be recorded on CallExtend’s Port 1 & 2 by using the **COMMANDS 2** and **3** in place of the **1** shown above. Different greetings are sometimes used in shared office environments or when separate day/night modes are used in the phone system. In addition to using separate greetings, you can direct the calls answered by Port 1 to a different receptionist than the calls answered by Port 2; to do this, see Appendix B, Case H.

To **RECORD** and **REVIEW** the main greeting for Port 1, you would dial the following on the ADMIN phone:

Dial: 0 7 2 Speak into the Admin Phone to record the greeting; hang up when done.

Dial: 0 7 0 Listen to the greeting.

Then, to RECORD and REVIEW a different greeting on Port 2, you would dial:

Dial: 0 7 3 Speak into the Admin Phone to record the greeting; hang up when done.

Dial: 0 7 * Listen to the greeting.

Replaying the Main Greeting: You can designate a particular digit (1-9 or * or #) to repeat the message when dialed. If a caller dials this digit at any time during or just after a message, they will hear the message played again from the beginning. **By default, the repeat digit is “*”** (e.g., “Dial * to hear this message again”). If you want to use a different digit or turn off the repeat function, see [Appendix B, Case F](#). Do not use a digit that corresponds to a PAGE you are using (e.g., if you are using PAGE 9, do not use “9” to repeat messages).

Recording a PAGE MESSAGE:

A PAGE MESSAGE is a second-level voice message that can be played to callers who dial a single digit from the main greeting. **A different PAGE Message can be recorded for each PAGE of CallExtend’s memory, PAGES 1 through 9.** All PAGE Messages should be recorded right AFTER the Main Greeting(s).

The applications for this type of message are endless but fall into two main categories, described next:

1) An **Informative Message**, such as this example:

Example: In their Main Greeting, the ABC Company has told callers to dial 6 to hear their address. This address message is programmed into PAGE 6, ROW 7 by dialing on the ADMIN phone as follows:

Page 6, Row 7 -	Dial: 6 7 1	Say, “Our office is located at 123 Main St., Anytown, USA.” Hang up when done.
	Dial: 6 7 0	Listen to the message.

2) A **Second Level Menu Message**, such as:

Example: In their Main Greeting, the ABC Company has told callers to dial 4 for Technical Support. DATA programming for this example was done on Page 24 of this manual. The second-level-menu message would be recorded into PAGE 4, ROW 7 by dialing on the ADMIN phone as follows:

Page 4, Row 7 -	Dial: 4 7 1	Say, “For assistance with Product A, press 1. For assistance with Product B, press 2.” Hang up.
	Dial: 4 7 0	Listen to the message.

Recording a TRANSFER MESSAGE:

A **Transfer Message can be recorded to play after the final extension or menu digit dialed by the caller** (before CallExtend performs the first hook-flash). The Transfer Message is ideal for informing callers about the progress of their call, especially if CallExtend is in a supervised mode, where the calling party will not hear ringing or busy signal.

This type of message should be recorded after the Main Greeting(s) and all PAGE Messages (if there are any) are recorded. **This message is programmed on PAGE 0, ROW 6.** To record it, you would dial on the ADMIN phone as follows:

Dial: 0 6 1 Say, “Please hold while I try that extension.” Hang up when done.

Dial: 0 6 0 Listen to the message.

Recording a BUSY-DON'T ANSWER (BDA) MESSAGE:

The Busy - Don't Answer (BDA) Message is an optional message that is only used if CallExtend is in a supervised mode (Full Supervision and Busy-Only Supervision are described on pages 10-11 of this manual). **If recorded, the BDA Message will play when CallExtend is not able to transfer a call to an extension because that extension is busy or doesn't answer.** After trying the extension, CallExtend will retrieve the call, play the BDA Message, and then transfer the call to the appropriate receptionist (the PAGE Receptionist if one is programmed, or else the BDA Receptionist if one is programmed, or the Main Receptionist).

The BDA message must be recorded LAST, after the Main Greeting(s), all PAGE Messages (if any), and the Transfer Message are recorded. **The BDA Message is recorded on PAGE 0, ROW 5**, by dialing on the ADMIN phone as follows:

Dial: **0 5 1** Say, "That extension is not answering; please hold for the receptionist."
Hang up when done.

Dial: **0 5 0** Listen to the message.

Erasing Voice Messages:

If you need to re-record a message, first erase the old message and then re-record the message in the same PAGE, ROW location. **Only the last message you have recorded can be erased and re-recorded.** If you need to re-record a message that is in between recorded messages, you should erase ALL the voice messages and begin again (this is done by dialing **0 7** and then holding **9** down for at least one second, until the Data display returns to **P**).

The chart on page 27 lists the **CallExtend Erase Commands: 4, 6, 8, and 9**. To erase a message, dial on the Admin Phone in the following format:

PAGE number 0-9	ROW number 5-7	ERASE command 4, 6, 8, or 9
------------------------	-----------------------	------------------------------------

As with all other CallExtend commands, the **ERASE command digit must be held down for at least one full second before being released.** When a message has been erased successfully, the CallExtend display will return to **P**.

Remaining Voice Message Storage:

When a message is reviewed using one of the **CallExtend Review Commands (0 or ★)**, CallExtend will play back the voice message to the ADMIN phone **and** display a single digit in the CallExtend display. This digit represents the approximate amount of remaining voice message storage (i.e., the amount of time still available for recording more messages). Following is a chart of these single digits and their values:

Digit displayed:	Approximate percent of total voice storage that is still available for recording messages:
A	All voice storage (98-100%) is available for use
9	90-97% is available for use
8	80-89% is available for use
7	65-79% is available for use
6	55-64% is available for use
5	45-54% is available for use
4	35-44% is available for use
3	25-34% is available for use
2	15-24% is available for use
1	3-14% is available for use
0	0-2% is available for use

Appendix A: Data Display

To make programming easier, CallExtend uses its Data display to provide information to the user. Watch this display for help during programming, and to see the results of a Review Data Command. The display works as follows:

- **P** -- When the receiver of the ADMIN phone is picked up, the Data display will show **P** (to indicate that CallExtend is in **Programming Mode** and is waiting for a **PAGE** number to be entered).
- **r** -- Once a PAGE number has been dialed, the Data display will show **r** to indicate that a **ROW** is needed next.
- **C** -- Once a ROW number has been dialed, the Data display will show **C** (to indicate that a **COMMAND** should be entered next); remember that command keys must be pressed and held down for at least one full second (until the display changes) before being released.
- **d** -- When the **5** key (Enter Data Command) has been held down long enough, the display changes to **d** (indicating that CallExtend is ready to receive **DATA**).
- **S** -- When the **1**, **2**, or **3** key (Record Voice Message Command) has been held down long enough, the display changes to **S** (indicating that CallExtend is recording your **SPEECH** message).

After a Review Data Command, the Data display shows the contents of the PAGE and ROW specified. Each digit is shown for a second, and then the next digit is displayed. Blanks are shown as **□** (small squares); an asterisk or star (*****) is shown as **//** (since the display can't form the shape *****), a pound character (**#**) as **c** and a

pause as **-** (a dash or hyphen). If an error occurs during programming, CallExtend beeps and shows **≡** (three lines).

The following chart summarizes the Data display:

Displayed:	Indicates:
P	waiting for a PAGE number to be entered
r	waiting for a ROW number to be entered
C	waiting for a COMMAND to be entered
d	waiting for DATA to be entered
S	Speech Mode: talk into the Admin phone to record a voice message
//	a * stored in memory
c	a # stored in memory
-	a pause stored in memory
□	a blank stored in memory
F	a hook-flash character stored in memory
≡	a programming error has occurred
R	98-100% of voice storage remains
0-9	in a Review Data Command, indicates the digit displayed is stored in memory; in a Review Voice Message Command, indicates amount of voice storage still available for use

NOTE: In normal operation (when the Admin Phone is hung up and CallExtend is answering calls), CallExtend will display digits as callers dial them and as CallExtend dials them when transferring calls. This display is useful for reference when trouble-shooting problems and is intended for use primarily by technical support personnel.

Appendix B: Optional Programming

Some phone systems require additional system settings beyond the basic ones detailed in the section, "Programming System Settings: PAGE 0, ROW 0." These optional settings are programmed into the various fields of PAGE 0, ROW 0 and PAGE *, ROW 0, and they are described in the cases in this Appendix.

If none of the cases in this Appendix applies to your installation, you need only program Fields 1, 2, & 3 of PAGE 0, ROW 0 as described on pages 9-11; the default values for the other fields will be used by CallExtend automatically. When you review the data after entering it, you will see blanks (▢) for the fields you didn't program.

Record your PAGE 0, ROW 0 settings here. To program, dial on the Admin Phone:

Dial:	0	0	5								← Field Numbers
				0	0	0	0	0	0	0	← Default values

Dial: 0 0 7 *Review the DATA to make sure it's correct.*

Record your PAGE *, ROW 0 settings here. To program, dial as shown:

Dial:	*	0	5				← Field Numbers
				0	0	*	← Default values

Dial: * 0 7 *Review the DATA to make sure it's correct.*

NOTE: To program any of the optional settings in a ROW, program all the fields in that ROW. See pages 9-11 to program Fields 1-3 of PAGE 0, ROW 0; use the default values shown for the other fields, unless one of the cases in this Appendix indicates otherwise.

Case A: Fully supervise call transfers in phone systems that don't provide ringing or busy tones to CallExtend. Field 4 of PAGE 0, ROW 0 can be set to 1 (one) to have CallExtend interpret the number 2-9 in Field 3 of that ROW (the Transfer Supervision Mode field) to be a time period, rather than a number of rings. In this case, Field 3 represents the amount of time (in 4-second increments) CallExtend will wait before transferring an unanswered call to the receptionist(s). **Example:** if PAGE 0, ROW 0's Field 4 is set to 1 (one), a 3 in Field 3 would tell CallExtend to wait 12 (4 x 3) seconds.

Case B: Disconnect supervised calls if the desired extension is busy or doesn't answer, instead of transferring the caller to the receptionist. CallExtend will play the "Busy - Don't Answer Message" (e.g., "that extension is not answering; please try again later") and then disconnect the caller. To use this option, put a 1 (one) in Field 1 of PAGE *, ROW 0 and set Field 3 of PAGE 0, ROW 0 to the number of rings 2-9 CallExtend should hear from an extension before declaring the call unanswered. If desired, you can have calls to a busy extension be disconnected but have calls to ringing extensions be cut through without further supervision by CallExtend; to do this, put a 1 (one) in both of these fields. When using this Supervised Disconnect feature, also see Case C.

Case C: Play the BDA Message instead of the Transfer Message to callers who don't dial from the Main Greeting. This field can be used with Case B to disconnect callers who don't dial anything from CallExtend's Main Greeting. If Field 2 of PAGE *, ROW 0 is set to 1 (one) and the Supervised Disconnect feature is turned on (Case B), callers who don't dial anything from the main greeting will hear the BDA Message and then be disconnected. If this field is set to 1 but Supervised Disconnect is not turned on, the caller will hear the BDA message and then be transferred to the Main Receptionist in PAGE 0. Leave this field set to 0 (zero) to have these callers hear the Transfer Message and go to the receptionist.

Case D: **Supervise calls on phone systems that are programmed for conference calling.** If the phone system's conference calling feature requires that an extra hook-flash be used to retrieve a call for a second transfer, Field 5 of PAGE 0, ROW 0 should be set to 4. In this case, CallExtend will do an extra (4th) hook-flash when transferring busy/unanswered calls to the receptionist.

Case E: **Have CallExtend answer calls after x number of rings, instead of on the first ring.** Program Field 6 of PAGE 0, ROW 0 to the number of times you want CallExtend to ring before it answers the call (e.g., "4" to answer on the fourth ring). Set this field to 0 (zero) or 1 (one) to have CallExtend answer on the first ring.

Case F: **Select a digit for callers to dial to repeat the message they last heard.** Program Field 3 of PAGE *, ROW 0 to the digit (1-9, *, or #) to be used as the Repeat Character. Whenever callers dial this digit during or right after a message, that message will be played again from the beginning. Do not select a digit that you have also programmed as a PAGE, or that PAGE will not work (e.g., if PAGE 6 is programmed, do not use "6" as the Repeat Character). If this field is set to 0 (zero), the repeat function will be turned off and there will be no Repeat Character. If this field is not programmed, the Repeat Character will be set by default to *.

Case G: **Direct calls to a receptionist extension longer than 8 digits or to an outside phone number.** This field affects both the Main Receptionists entered into PAGE 0 and the BDA Receptionists entered into PAGE *. First, in ROW 0 of PAGE 0, program a # character into Field 7 (dial ## to enter a # character into this field). Then, program the receptionist extensions into PAGES 0 and * as follows: In ROW 1, enter the first 8 digits of the extension or phone number. In ROW 2, enter the remainder of the number. After this, CallExtend will direct calls to this receptionist to the complete number entered into ROWS 1 and 2. In this case, only one receptionist can be entered into PAGE 0 and one receptionist into PAGE *.

NOTE: When using an outside phone number as the receptionist, you may need to modify Field 8 of PAGE 0, ROW 0. If CallExtend dials an outside phone number and then immediately exits the call, some phone systems will not connect the caller to the outside phone line. If this is the case, program Field 8 to the number of seconds (1-9) CallExtend should stay on the line

after dialing the receptionist's number, before it exits the call and connects the caller through. This setting will affect BOTH the Main and BDA Receptionists but not the PAGE Receptionists. As an alternative to setting this field, you can add pauses to the end of the phone number you program (see Case I for this).

Case H: **Have calls answered by CallExtend's Port 1 be directed to a different receptionist than calls answered by Port 2.** This field affects both the Main Receptionists entered into PAGE 0 and the BDA Receptionists entered into PAGE *. Program a 1 (one) into Field 7 of PAGE 0, ROW 0 and then program the receptionist extensions for both PAGES 0 and * as follows: In **ROW 1**, enter the extension to serve as receptionist for CallExtend's Port 1, up to 8 digits. Enter any remaining digits in ROW 2; if none, leave ROW 2 blank. In **ROW 3**, enter the receptionist extension for CallExtend's Port 2, up to 8 digits. Enter any remaining digits in ROW 4; if none, leave ROW 4 blank.

Case I: **Have CallExtend PAUSE while dialing.** CallExtend can be programmed to pause between or after digits when dialing extensions or outside phone numbers. Each "pause" is 2 seconds in length, and multiple pauses can be used. To program a pause into CallExtend, program the dialing string normally; at each spot you want CallExtend to pause while dialing, enter a pause character by dialing #* on the ADMIN phone (a single # sign followed immediately by a single * without a significant delay). The pause counts as a single digit and uses one space in CallExtend's memory; when reviewing data, you will see a - (dash) for each pause.

NOTE: CallExtend automatically pauses 2 seconds after dialing the first digit of an extension or phone number that begins with 8, 9, 0, *, or a # character. If a #* pause is added after the initial 8, 9, 0, *, or # character, CallExtend will pause a total of 4 seconds before dialing the next digit.

Case J: **Have CallExtend hook-flash in between dialed digits.** CallExtend can be programmed to hook-flash in between digits when dialing an extension. This is a rare application used by only a few ACD and Centrex applications and a very few phone systems. In this case, program the dialing string normally; at each spot you want CallExtend to do a hook-flash while dialing, enter a hook-flash character by

dialing **#8** on the ADMIN phone (a single **#** sign followed immediately by a single **8** without a significant delay). The hook-flash character counts as a single digit and uses one space in CallExtend's memory; when reviewing data, you will see an **F** for each hook-flash character. Note: CallExtend will still use its normal hook-flashes when transferring calls; these do **NOT** need to be programmed.

Case K: **Have CallExtend detect a different Calling Party Abandon.** In most cases, a phone system will pass through some kind of signal to the extension handling an incoming call, to indicate a call has been abandoned by the calling party. After the main greeting has finished playing, CallExtend will look for either dial-tone or an interruption in loop current passed through to it as an indication that the calling party has hung up during the greeting. If CallExtend detects either of these, it will return to an idle state without sending the call to the receptionist.

There is no adjustment required for CallExtend to recognize dial-tone as a calling party abandon signal, but there may be an adjustment needed for CallExtend to recognize the length of current interrupt passed through to it as an abandon signal. This is controlled in Field 2 of PAGE 0, ROW 0 as follows:

- Entering a digit 0-9 in Field 2 of PAGE 0, ROW 0 will cause CallExtend to look for dial-tone or an interrupt duration of 400 ms as a call abandon. If CallExtend doesn't see either of these, it will pause the number of seconds corresponding to the digit programmed (to allow the caller to dial) and then transfer the call.
- Entering a **★** character in Field 2 of PAGE 0, ROW 0 will cause CallExtend to look for dial-tone or an interrupt duration of 80 ms as a call abandon. If CallExtend doesn't see either of these, it will pause 5 seconds to allow the caller to dial, and then it will transfer the call.
- Entering a **#** character in Field 2 of PAGE 0, ROW 0 (dial **##** to enter a **#** character into this field) will disable the call abandon detect feature and allow a 5 second pause duration.

WARNING: Some phone systems do not pass through any type of call abandon signal to an extension port that has received an incoming call. If CallExtend does not receive any notification that a call has been abandoned during the greeting, it has

no way of knowing that the call was dropped. In this case, it will transfer the call to the receptionist after the main greeting has been played, just as it would if the calling party had stayed on the line but dialed nothing. **It is important to make sure these abandoned calls are answered by an extension and then hung up**, or else the phone system will still consider the call to be valid. If there is no receptionist to answer the call, the phone system may continue to ring the abandoned call through to its extensions indefinitely. For this reason, if your receptionist station is unattended at times and your phone system does not pass through call abandons, you should use an answering machine as the final extension in your phone system's receptionist hunt group.

Appendix C: Troubleshooting

If you experience problems when installing CallExtend, the following examples may assist you in troubleshooting:

Call Transfer Problems:

Calls are not being transferred, and touch-tone digits are heard by the caller:

1. The hook-flash duration setting in CallExtend may be too short for the phone system. Check the "Hook-Flash Duration" Field (the first field of PAGE 0, ROW 0) to make sure it is set to correspond to the hook-flash duration setting in the phone system.
2. Make sure that the phone system analog ports CallExtend is connected to are programmed for call transfers. To test this, see page 2.
3. Make sure CallExtend has been programmed to dial any prefix digits that are needed in front of extension numbers when transferring calls, as well as any digits needed after the extension.

The caller dials to select a department or extension, and the call is dropped without touch-tone digits being heard: The hook-flash duration CallExtend is using when transferring calls may be too long for the phone system. Change the value programmed into the first Field of PAGE 0, ROW 0 to a lower value that matches the hook-flash duration setting in the phone system.

The caller dials a single digit but is not transferred to an extension: Make sure that ROW 0 on that single digit's PAGE is set to ★ (star). Also, review the data in ROWS 1-6 on the PAGE, to make sure that the desired extensions have been programmed correctly.

A call is transferred to an extension, but that extension only rings briefly before the call is transferred to the receptionist: Set the "Transfer Supervision Mode" field in PAGE 0, ROW 0 to a higher number of rings (see "Programming System Settings: PAGE 0, ROW 0").

If a call is not answered by the extension it was transferred to, it is not being transferred to the receptionist or is being transferred to the wrong receptionist:

1. The "Transfer Supervision Mode" setting in PAGE 0, ROW 0 may be set to zero or one. This causes CallExtend to transfer the call without answer supervision. See "Programming System Settings: PAGE 0, ROW 0" to change this value.
2. If this problem occurs when CallExtend is set to fully supervise call transfers, check the PAGE Receptionist entered into ROWS 8-9 of the PAGE that handled the call (see page 16 of this manual to confirm that this extension is programmed correctly). Next, check the BDA Receptionist extensions entered into PAGE ★, ROWS 1-4. If an extension is entered in these ROWS, it will be used as the receptionist for calls that do not have a PAGE Receptionist programmed. Next, check the Main Receptionist extensions entered into PAGE 0, ROWS 1-4.
3. Make sure your telephone system can make a second call transfer from the analog ports without any restrictions.
4. If the conference calling feature on your phone system causes an extra hook-flash to be needed for the second call transfer, see Appendix B, Case D.

CallExtend seems to tie up a phone line for a long period of time without transferring a call:

1. This may occur because the phone system does not pass a calling party abandon signal (interruption in line current or dial-tone) to the CallExtend extension, or the phone system passes through a shorter signal than CallExtend is programmed to recognize. Check the programming referred to in Appendix B, Case K.
2. If CallExtend does not have a proper receptionist extension programmed into it, it will not be able to transfer callers who wait on the line to reach the receptionist (e.g., if they are calling from a rotary phone); thus, these callers may be kept on the line indefinitely. Verify that PAGE 0, ROW 1 has been programmed with a receptionist extension that will be answered.

Voice Message Problems:

The greeting is played twice to callers: With some phone systems, if an extension does not answer a transferred call, the call is automatically returned to the extension that originated the call transfer. In this case, calls will be transferred back to CallExtend if they are not answered by the appropriate extension. When the call is transferred back to CallExtend, it looks like a new call, so CallExtend plays its greeting to the caller. Program the phone system to not transfer calls back to the ports used with CallExtend. If this cannot be done, extend the phone system's extension recall timer. This problem can also occur when CallExtend is in Supervised mode, if the phone system rings calls that are on hold back to CallExtend too soon; in this case, lengthen the phone system's hold recall timer so it is longer than the number of rings CallExtend is set to supervise (see "Programming System Settings: PAGE 0, ROW 0" to set the number of rings CallExtend supervises).

CallExtend answers calls but does not play any messages to the caller: The voice messages may have been erased by a power failure and should be re-recorded. Also, check the "Batt. Low" light on CallExtend; if this light is on, a new battery should be inserted in the battery backup prior to re-recording the messages.

CallExtend allows calls to be transferred, but the Transfer Message and BDA Message are not being heard by the caller: These messages may have been re-recorded after they were originally recorded, without being erased first. Whenever you need to re-record a message, you must first erase the old one. Erase all messages and re-record them all, in the order described on page 26.

A voice message stops part-way through (always at the same place), and the caller is immediately transferred to an extension or the receptionist: Part of the voice message may sound like a touch-tone digit to CallExtend, causing the call to be transferred. If the digit is programmed, CallExtend will transfer the caller to the appropriate department; if it is not programmed, the caller will be transferred to the receptionist. Erase all voice messages and re-record them all, in the order described on page 26.

A voice message stops part-way through at a random point, and there is a pause before the call is disconnected or is transferred to the receptionist: CallExtend

may be located near a transformer or power supply that emits a strong magnetic field, causing CallExtend to lock up. Relocate the CallExtend unit.

How to Reach Customer Support:

If you encounter problems you are not able to resolve with your CallExtend system, contact your CallExtend dealer or Call Management Products Inc., Broomfield, Colorado, at (303) 465-0651 or (800) 245-9933.

Returning a CallExtend for Repair:

If you suspect that your CallExtend may need repair, contact our Customer Support Department from the site where CallExtend is connected. A technician will ask you some questions about the installation and will go through some tests over the phone.

If the Customer Support technician determines that the CallExtend needs to be returned for repair, he or she will issue you a **Return Merchandise Authorization (RMA) number**.

CallExtend comes with a 1-year warranty on parts and labor. If the manufacture date on the bottom of the CallExtend is over 12 months old, a photocopy of the actual sales receipt is required to prove the purchase date. Out-of-warranty repairs are available.

Warranty:

Call Management Products Inc. (CMP) warrants this product, so far as the same is of its own manufacture, against defects in material and workmanship under the normal use and service for which it was designed, for a period of one year from date of initial end user purchase. CMP's obligation under this warranty is limited, however, to the replacement or repair, at its option, to a part or parts determined by it to be defective. Necessary packaging and transportation costs for the return of the goods shall be paid by the buyer. All replacement or repaired goods will be returned prepaid by CMP. This limited warranty does not include damage resulting from accident, abuse, or non-factory modification of the product.

CMP shall under no circumstances be liable for any special, indirect, or consequential damages owing to failure of the product. SELLER MAKES NO WARRANTY OF FITNESS OR MERCHANTABILITY AND NO OTHER WARRANTY, ORAL OR WRITTEN, EXPRESS OR IMPLIED, EXCEPT AS SPECIFICALLY SET FORTH HEREIN.

FCC Notice:

- 1.) This equipment complies with Part 15 and Part 68 of the FCC rules. On the bottom of the CallExtend unit is a label that contains, among other information, the FCC registration number and the ringer equivalence number (REN) for this equipment. If requested, this information must be provided to the telephone company.
- 2.) This equipment uses the following USOC jacks: RJ11C.
- 3.) The Ringer Equivalence Number (REN) is used to determine the quantity of devices that may be connected to the telephone line at one time. The REN characterizes the load placed on the telephone company alerting (ringing) power source by this product, as a ratio to a standard mechanical bell-type ringer. Excessive RENs on the telephone line may result in the devices not ringing in response to an incoming call. In most, but not all areas, the sum of the RENs

should not exceed five (5.0). To be certain of the number of devices that may be connected to the line, as determined by the total RENs, contact the telephone company to determine the maximum REN for the calling area.

- 4.) If this equipment causes harm to the telephone network, the telephone company has the right to discontinue service temporarily on the line to which this product is connected. The telephone company will notify you in advance if temporary discontinuance of service is required. If advance notification isn't practical, the telephone company will notify you as soon as possible. Also, you will be advised of your right to file a complaint with the FCC if you believe it is necessary.
- 5.) The telephone company may make changes in its facilities, equipment, operations, or procedures that could affect the operation of this equipment and could make it incompatible or less compatible. If this happens, the telephone company will provide advance notice in order for you to make the necessary modifications to maintain uninterrupted service.
- 6.) If trouble is experienced with this equipment, please contact your local dealer or Call Management Products Inc. (CMP) for repair or warranty information. If the trouble is causing harm to the telephone network, the telephone company may request that you remove the equipment from the network until the problem is resolved. Under no condition is any equipment to be sent to CMP without contacting CMP in advance for return authorization.
- 7.) No repairs can be done by the customer.
- 8.) This equipment cannot be used on telephone company provided coin service. Connection to Party Line Service is subject to state tariffs.
- 9.) This equipment is hearing-aid compatible.

Call Management Products Inc. reserves the right to make improvements to the product described in this manual at any time and without notice.

This manual is copyrighted. All rights are reserved. This document may not, in whole or part, be copied, photocopied, reproduced, translated, or reduced to any electronic medium or machine readable form without prior consent, in writing, from Call Management Products Inc.

Copyright 1997 by Call Management Products Inc., Broomfield, Colorado.

CallExtend

User's Manual

Rev. 97A0211